

COPYRIGHT
 THIS DOCUMENT AND THE IDEAS AND DESIGNS INCORPORATED HEREIN, ARE THE SOLE PROPERTY OF HOT SPRINGS POOLS AND SPAS INC. AND ARE NOT TO BE ALTERED, REPRODUCED OR USED, IN WHOLE OR IN PART FOR ANY OTHER PROJECT WITHOUT THE EXPRESSED WRITTEN AUTHORIZATION OF HOT SPRINGS POOLS AND SPAS, INC.

REVISIONS
 11-16-2015 Revised per Beaufort Co. Comments

NEW INDOOR COMMERCIAL POOL PLANS
 FOR
Fairfield Inn and Suites
 2090 W 15th Street, Washington, NC 27889
 Beaufort County

HOT SPRINGS POOLS & SPAS
 Since 1989
 578 WOODRUFF ROAD
 GREENVILLE, SC 29607
 (864) 676-9400 (TELEPHONE)
 (864) 329-1548 (FAX)

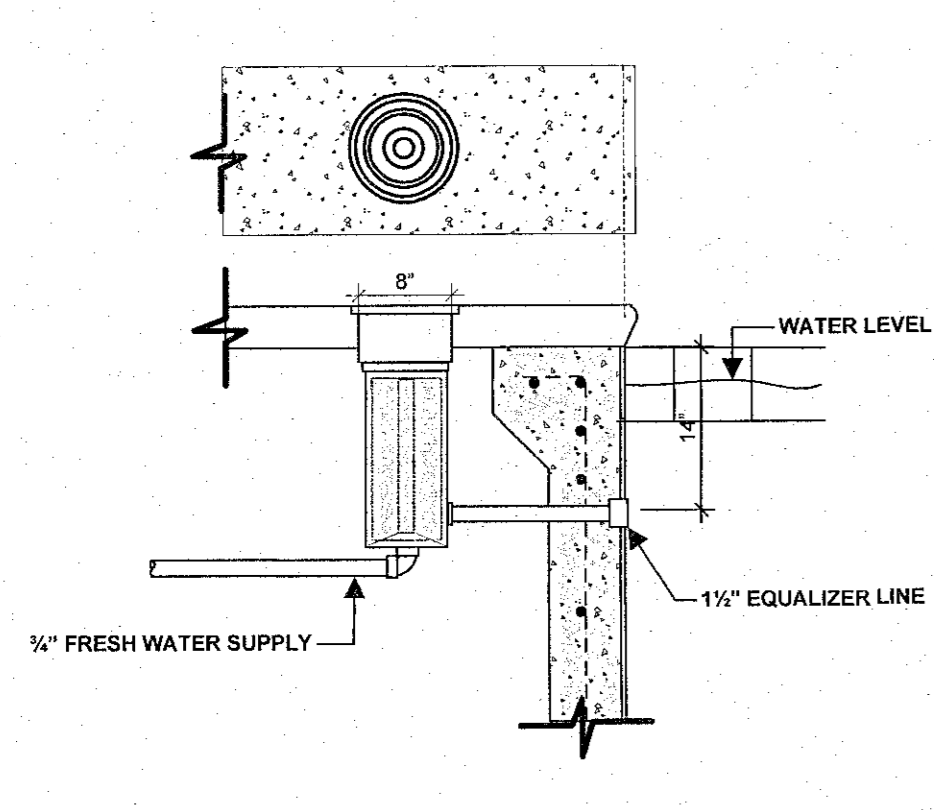

AUTOMATIC FILL DETAIL
 N.T.S.

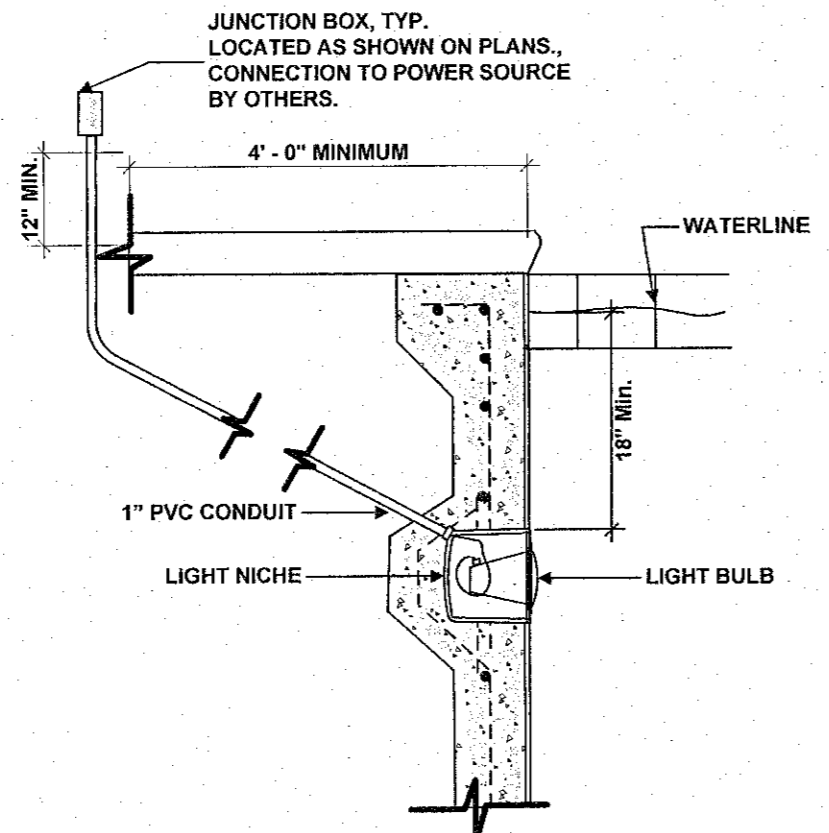

LIGHT DETAIL
 3/4" = 1'-0"

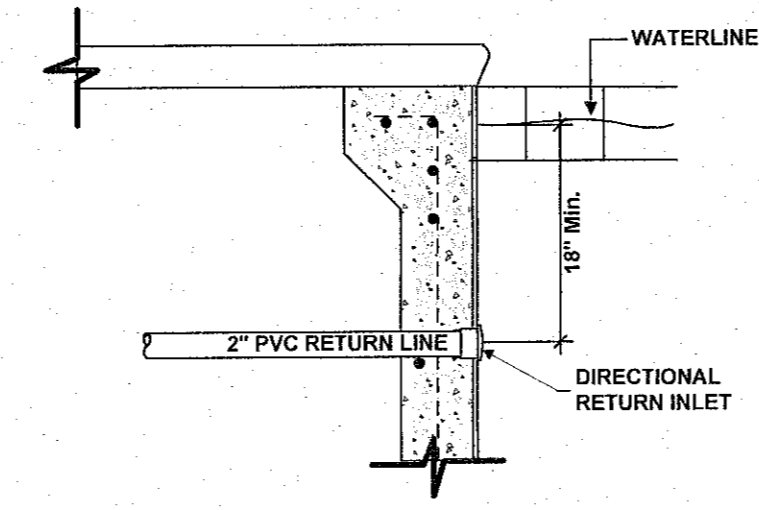

RETURN INLET DETAIL
 3/4" = 1'-0"

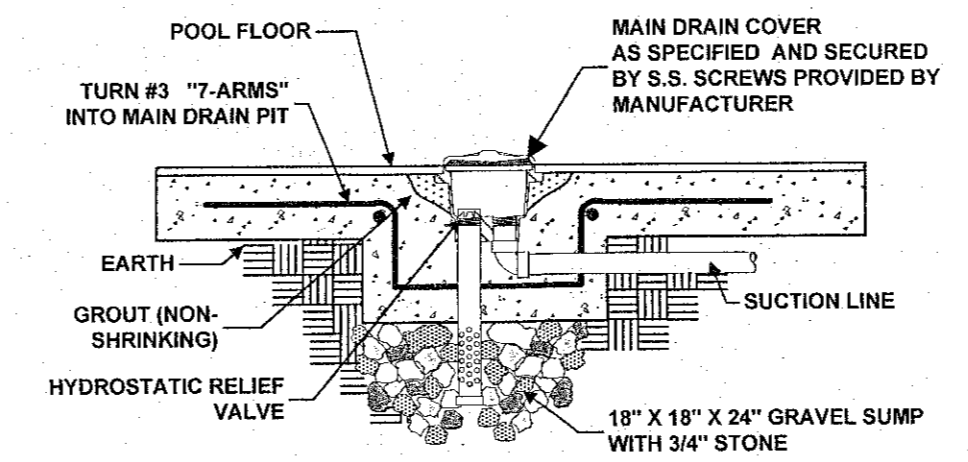

MAIN DRAIN DETAIL
 N.T.S.

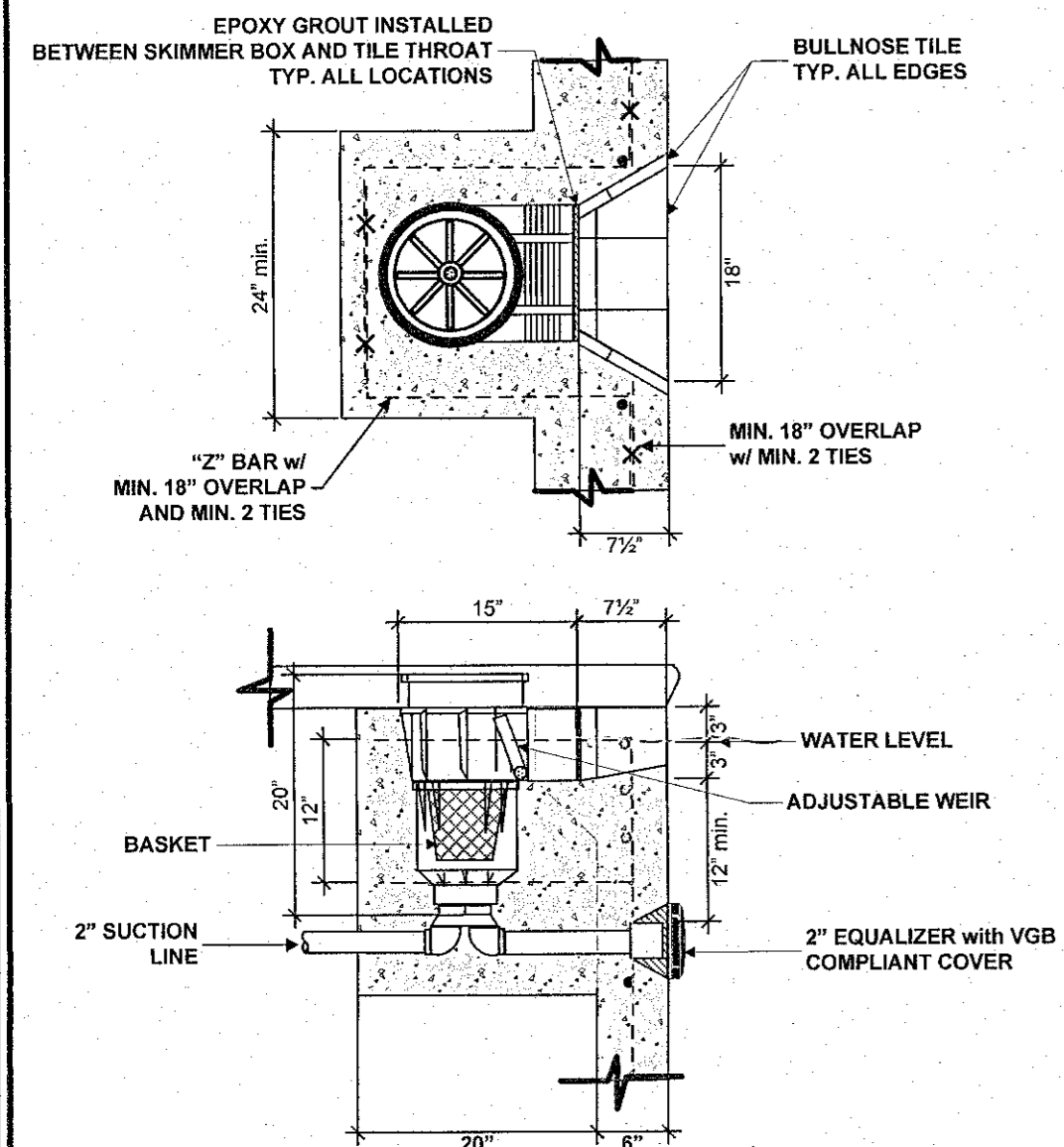

SURFACE SKIMMER DETAIL
 N.T.S.

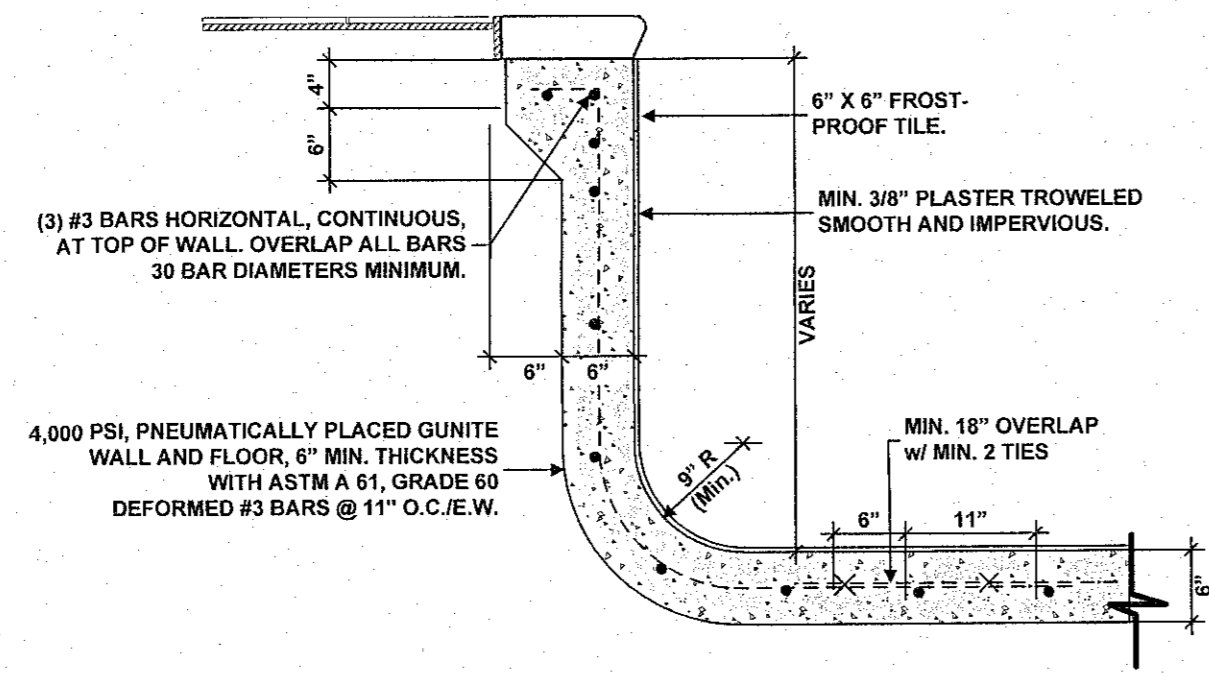

BOND BEAM DETAIL
 3/4" = 1'-0"

NOTE:
 RAIL MATERIAL: MARINE GRADE
 316L-1.90 OD X 0.120 WALL SS TUBE

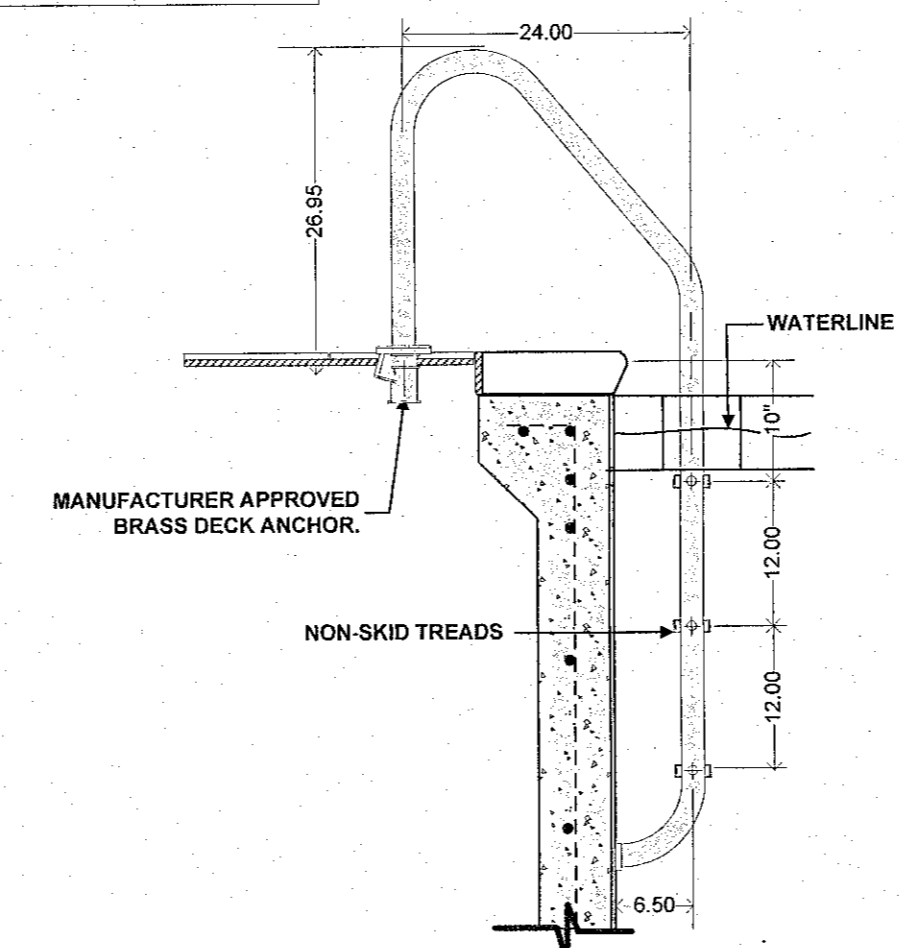

LADDER DETAIL
 3/4" = 1'-0"

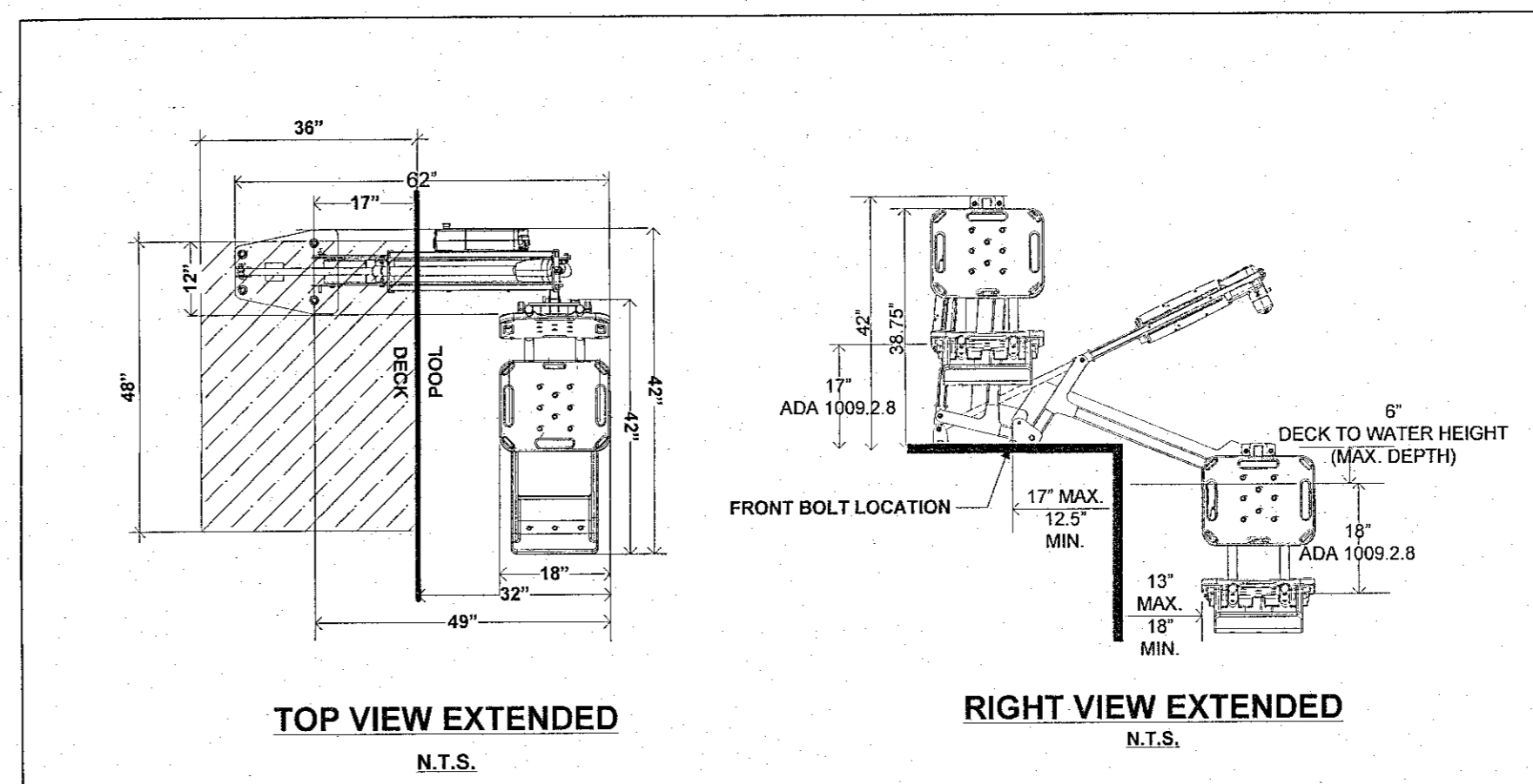

S. R. SMITH multi-Lift™

- 3rd Party tested and verified ADA 2010 Standards for Accessible Design Compliant
- 350lb lifting capacity
- Flange mounted with four anchor bolts
- Powered by the LiftOperator™ Intelligent Control System

NOTE:
 BATTERY RECHARGING STATION CAN BE LOCATED IN THE HOTEL OR AT POOLSIDE IN A CABINET.
 LOCATION MUST REMAIN UNLOCKED AND ACCESSIBLE DURING POOL HOURS.
 CHARGING STATION CAN NOT BE LOCATED IN THE POOL EQUIPMENT ROOM, POOL CHEMICAL STORAGE ROOM OR ANY LOCATION WHERE THERE ARE CAUSTIC CHEMICALS.

HANDICAP LIFT
 N.T.S.

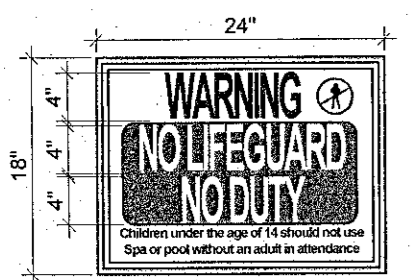

R230500 No Lifeguard On Duty
 24" X 18"

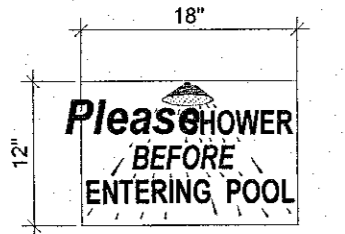

40320 Please Shower
 12" X 18"

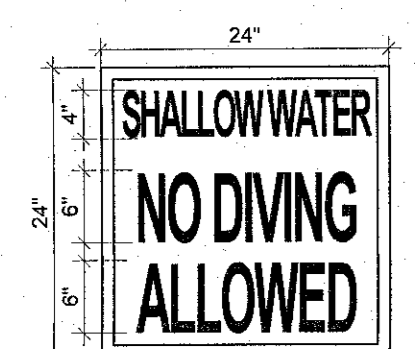

R233800 No Diving
 24" X 24"
 (4 in. X 6 in. letters)

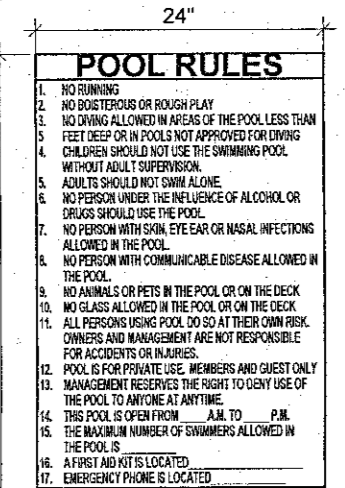

R234100 Pool Rules
 (N. Carolina), 24" X 36"

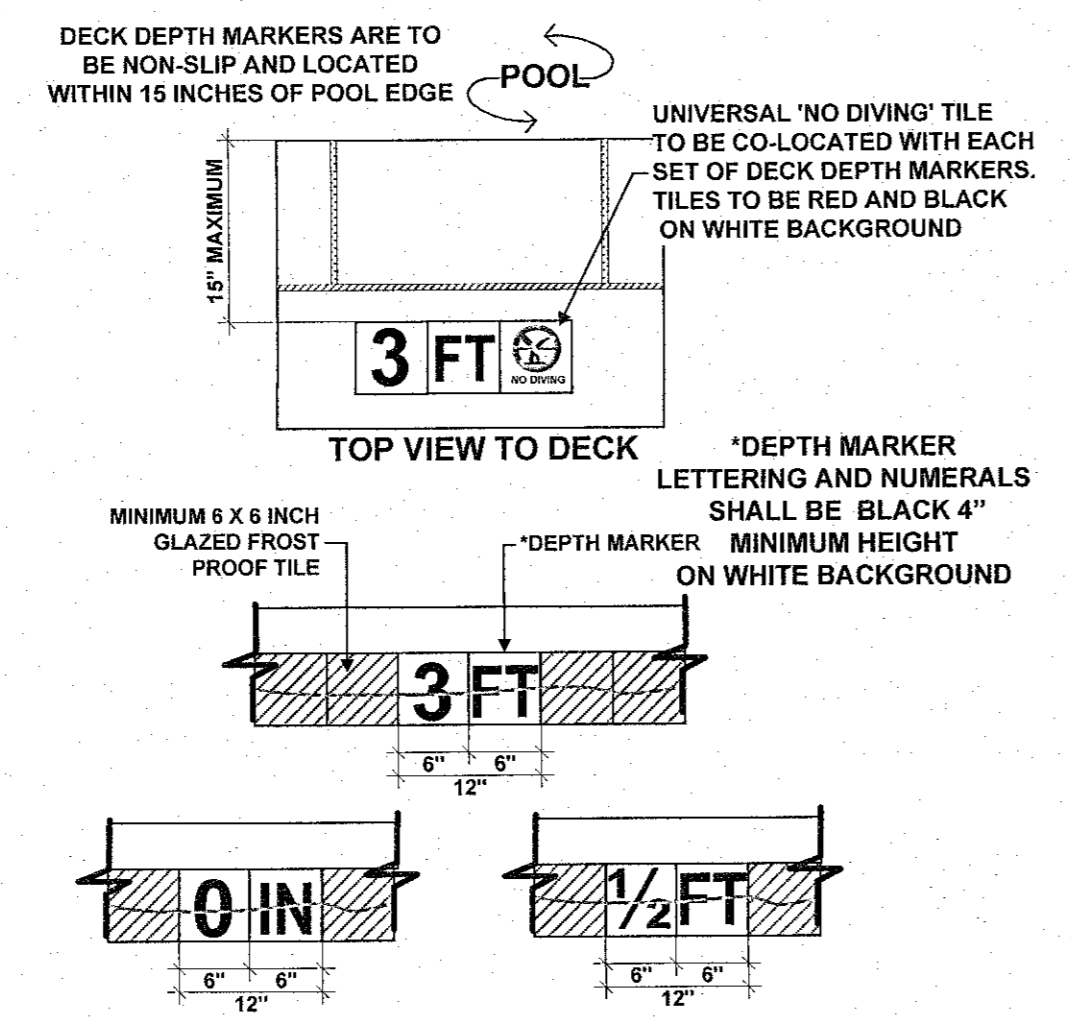

DEPTH MARKER DETAIL
 N.T.S.

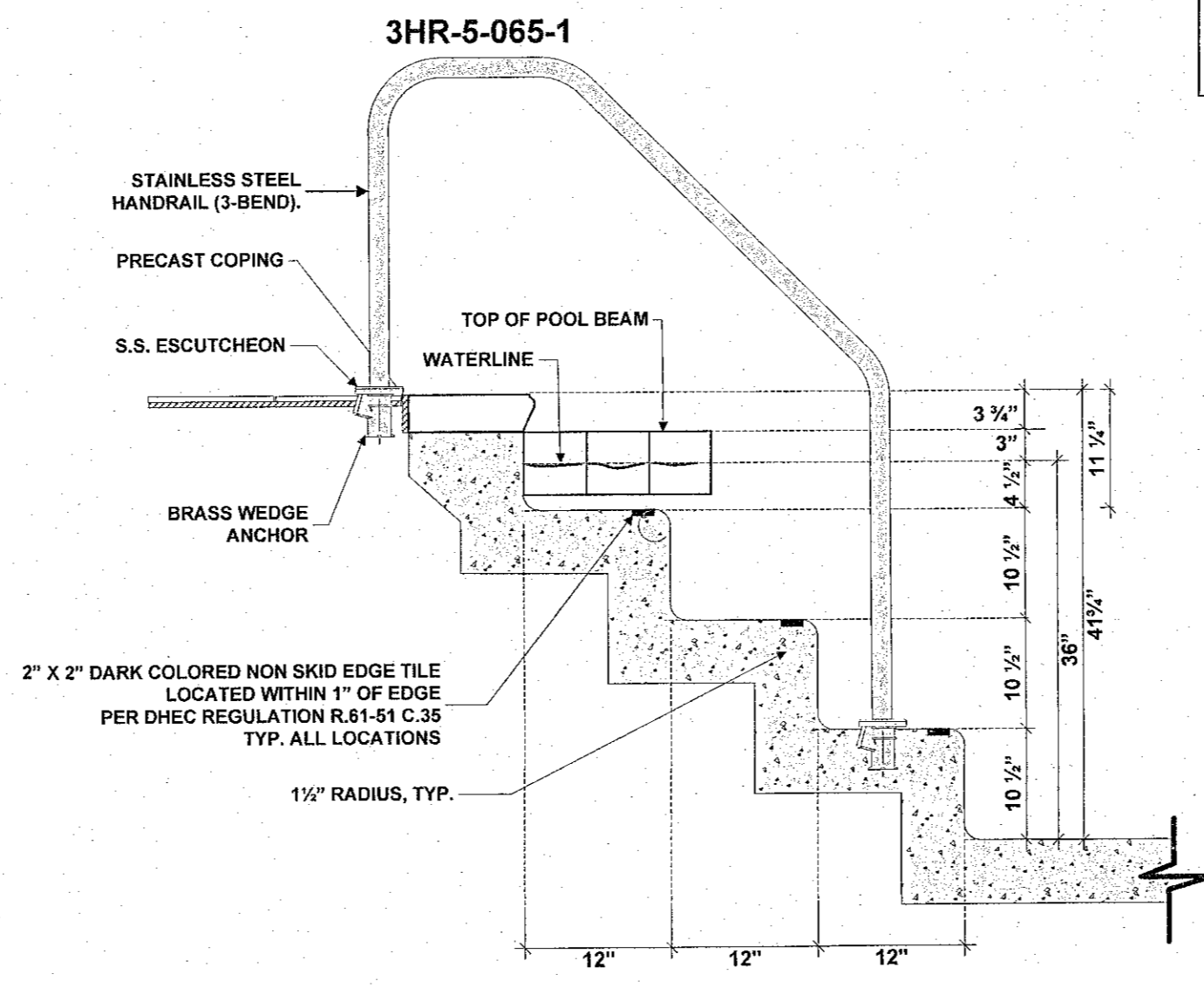

POOL STEP DETAIL
 N.T.S.

NOTE:
 PLANS ARE FOR POOL CONSTRUCTION ONLY.
 ALL BUILDING, EQUIPMENT & CHEMICAL ROOM NOTES AND SPECIFICATIONS ARE FOR COORDINATION AND INFORMATION ONLY.
 ELECTRICAL DATA IS FOR COORDINATION AND INFORMATION ONLY.
 IT IS THE RESPONSIBILITY OF OTHERS TO PROVIDE ANY REQUIRED REVISED CONSTRUCTION DRAWINGS INCLUDING BUT NOT LIMITED TO PLUMBING, MECHANICAL AND ELECTRICAL CHANGES NECESSARY FOR POOL PERMIT AND INSTALLATION.

Pentair Pool & Spa Signs
 Rainbow's commercial quality pool and spa signs meet specifications and safety requirements of state, county and city health codes. Each sign is constructed of weather-resistant, high impact plastic, screened with permanent inks and finished with brass grommets for easy, secure hanging.

DRAWN BY: RBH
 CHECKED BY: RRP
 DATE: July 29, 2015
 SCALE: AS NOTED
DETAILS
SP - 6